



2022 V1.0

# INSTALLATION GUIDE

SEG SOLAR DG AND BG PHOTOVOLTAIC MODULE



SEG SOLAR INC. (SEG)

**ADD:**

SEG Headquarter California office:  
6200 Stoneridge Mall Rd., Ste 300 Pleasanton, CA 94588

SEG San Antonio, Texas office:  
973 Isom Road San Antonio, TX 78216

T: 925-468-4198

WEB: [www.segsolar.com](http://www.segsolar.com)

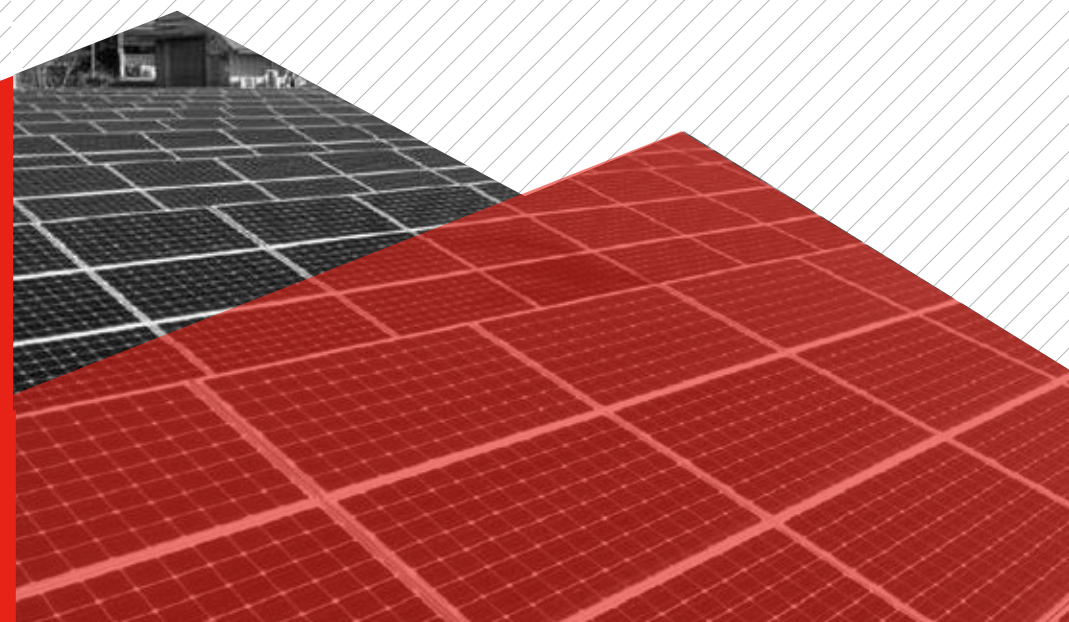

**UL** INSTALLATION GUIDE  
FOR  
SEG SOLAR DUAL GLASS PHOTOVOLTAIC MODULE

**TABLE OF CONTENTS**

<b>1 PURPOSE OF THIS GUIDE</b> .....	2
1.1 APPLICABLE PRODUCTS .....	2
<b>2 SAFETY</b> .....	2
2.1 GENERAL SAFETY .....	2
2.2 HANDLING SAFETY .....	3
2.3 INSTALLATION SAFETY .....	4
2.4 FIRE SAFETY .....	5
<b>3 PRODUCT IDENTIFICATION</b> .....	5
<b>4 MECHANICAL INSTALLATION</b> .....	6
4.1 GENERAL INSTALLATION PRINCIPLE .....	6
4.2 LOCATION AND ANGLE SELECTION .....	6
4.3 CLAMP INSTALLATION 1 .....	7
4.4 CLAMP INSTALLATION 2 .....	9
4.5 SCREW INSTALLATION .....	11
4.6 ELECTRICAL INSTALLATION .....	14
<b>5 MAINTENANCE</b> .....	15
<b>6 PARAMETERS</b> .....	16

# 1 PURPOSE OF THIS GUIDE

Thanks for choosing SEG Solar Photovoltaic Modules (hereafter referred to as “PV Module” ), This Guide is to give information on how to apply SEG Solar PV modules properly.

Installers must read and understand this Guide prior to installation. For any questions, please contact our technical department (technic@segsolar.com) for further information. Installers should follow all safety precautions described in this Guide as well as local codes when installing a module.

Keep this Guide in a safe place for future reference (care and maintenance) and in case of sale or disposal of the PV modules.

## 1.1 APPLICABLE PRODUCTS

This document is applicable to the series of PV modules as listed below:

Type 1	SEG-XXX-6PB-DG, SEG-XXX-6MB-DG, SEG-XXX-6MB-BG
Type 2	SEG-XXX-6PA-DG, SEG-XXX-6MA-DG, SEG-XXX-6MA-BG
Type 3	SEG-XXX-BPB-DG, SEG-XXX-BMB-DG, SEG-XXX-BMB-BG
Type 4	SEG-XXX-BPA-DG, SEG-XXX-BMA-DG, SEG-XXX-BMA-BG
Type 5	SEG-XXX-BMZ-BG
Type 6	SEG-XXX-BMC-BG
Type 7	SEG-XXX-BMD-BG

-BG Module : Bifacial dual-glass module  
 -DG Module : Single side dual-glass module  
 XXX: Module power

# 2 SAFETY

## 2.1 GENERAL SAFETY

- The PV module is used in systems operating at greater than 50 VDC or 240 W where general access is anticipated. The PV module is certified for safety through UL 1703 and within this application class are also certified to meet the requirements for fire safety Type 1 or 2.
- The PV modules shall be properly grounded in accordance with the instructions in this Guide or the requirements of the National Electrical Code.

- Installing PV modules requires specialized skills and knowledge. Installation should only be performed by qualified personnel, electrical connections requires a licensed electrician , where applicable according to local code and law (i.e. the NEC for the USA and CEC for Canada).
- Installers should assume all risks of injury that might occur during installation, including, but not limited to, the risk of electric shock.
- One single PV module may generate more than 30V DC when exposed to direct sunlight. Access to a DC voltage of 30V or more is potentially hazardous.
- PV modules convert light energy to DC electrical energy, which are designed for outdoor use. PV modules can be mounted onto ground, rooftop, vehicles or boats etc. The proper design of support structures lies within responsibility of the system designers and installers.
- Do not use mirrors or other magnifiers to concentrate sunlight onto the PV modules.
- When installing the PV modules, abide to all local, regional and national statutory regulations. Obtain a building permit if necessary.
- Only use equipment, connectors, wiring and support frames compatible with the PV modules.

## 2.2 HANDLING SAFETY

- Do not lift the PV module by grasping the module’ s junction box or electrical leads.
- Do not stand or step on the PV modules or place heavy objects onto it.
- Do not drop the PV module or allow objects to fall on the PV module.
- Do handle with care when move, transport and install the PV modules.
- Do not lean modules on other objects.
- Do apply soft protector to separate the modules when stacking modules and ensure the safety
- Do not attempt to disassemble the PV modules, and do not remove any attached nameplates or components from the PV modules.

- Do not apply paint or adhesive to the PV module top surface.
- Do not use PV modules with broken glass which has danger of electrical shock.
- Do not handle panels in wet condition unless has appropriate protection.
- Do not expose PV module to sunlight until installation to avoid unnecessary degradation.

### 2.3 INSTALLATION SAFETY

- Installation shall be in conformity with UL standard, Safety Standard for Electrical Installations.
- Do not disconnect under load.
- Do not touch conductive parts of PV modules, such as terminals which can result in burns, sparks and lethal shock whether or not the PV module is connected.
- Do not touch the PV module unnecessarily during installation.
- Do not work in the rain, snow or windy conditions.
- Do not expose the artificially sunlight to PV modules. Completely cover the PV module with an opaque material during installation to prevent electricity from being generated.
- Do not drill holes on the modules of broke the encapsulation on the module side.
- Do not wear metallic rings, watchbands, ear, nose, lip rings or other metallic objects while installing or troubleshooting.
- Only use insulated tools that are qualified for working on electrical installations.
- Follow the safety regulations for all other system components, including wires and cables, connectors, charging regulators, inverters, storage batteries, rechargeable batteries, etc.
- Under normal outdoor conditions the current and voltage generated will differ from those listed on the datasheet. When design systems, current and short-circuit current should be multiplied by a factor of 1.25 to determine components ratings.

- Only use connectors compatible with the PV module connectors. Removing the connectors without prior authorization will invalidate the warranty.
- Do not dismantle installed modules to another project, which may invalidate the warranty.

### 2.4 FIRE SAFETY

- The fire rating of this module is valid only this Guide is followed.
- Consult your local authority for Guidelines and requirements for building or structural fire safety.
- Do not use PV modules near equipment or in places where flammable gases may be generated.
- Follow local codes and laws when install the modules

## 3 PRODUCT IDENTIFICATION

Each module has two Barcode stickers which have the same unique serial No. of each module and one label sticker:

Barcode 1: Laminated into PV modules.

Barcode 2: Stick on the backside of PV modules.

Label: Stick on the backside of PV modules, contains characteristics parameters of the PV modules.

Check the serial No. in the barcode with the packing list when unpacking. Provide PV module serial No. when you need support from SEG Solar on particular PV modules.

## 4 MECHANICAL INSTALLATION

### 4.1 GENERAL INSTALLATION PRINCIPLE

- Module can be installed in both landscape and portrait modes <sup>[1]</sup>
- The clamp shall not shade the front side of the cells.
- The PV modules shall be installed high enough to keep it away from potential shading, flying sands, snow and water.
- It is recommended to install the PV modules 30cm away from the ground to make sure ventilation.
- It is recommended to install the bifacial modules 1m away from the ground or roof to maintain the energy yield of module rear side.
- Appropriate installation structures shall be chosen to meet required mechanical load.
- It is recommended to install the PV modules with minimum angle of 10 degree to make the dust easily to be washed off.
- It is recommended to keep minimum 2cm gap between PV modules for thermal expansion of materials.
- Install PV modules appropriately according to corresponding mechanical load need.

### 4.2 LOCATION AND ANGLE SELECTION

It is recommended to install PV modules where has excellent sunlight resources. In the Northern Hemisphere, the module should typically face south, and in the Southern Hemisphere, the modules should typically face north. The most optimistic installation angle varies according to different latitudes and longitudes; please consult experts with appropriate knowledge background when determining the installation locations and angles.

When choosing a site, avoid trees, buildings or obstructions, which could cast shadows on the solar photovoltaic modules. Shading causes hotspot and loss of output, even though the factory fitted bypass diodes of the PV module will minimize such effect.

Do not install the PV module near naked flame or flammable materials.

Do not install the PV module in a location where it would be immersed in water or constantly exposed to water from a sprinkler or fountain etc.

### 4.3 CLAMP INSTALLATION 1

The frameless dual glass module is designed for clamp installation. It need the clamps with rubber strips to fix on the bracket. Figure 1 and figure 2 show the structure of two kind of clamps.

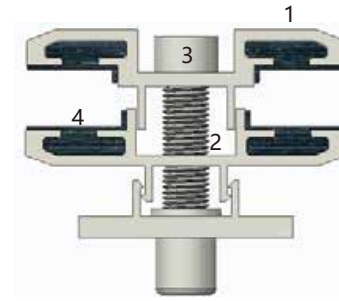

Figure 1 Double-side clamp

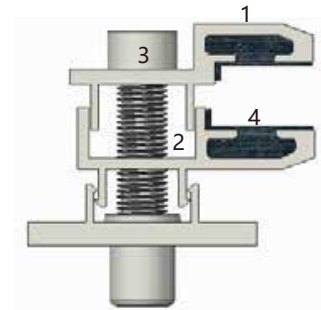

Figure 2 Single-side clamp

NO.	Name	Remark
1	Aluminium alloy	6063-T5
2	Spring	
3	Bolt	M8 stainless steel bolt
4	Rubber strip	Ethylene Propylene Diene Monomer ( EPDM )

Table 1 Components of the clamp

In order to ensure that the modules can withstand a downward force of up to 2400 Pa (244 kg/m<sup>2</sup>), the modules shall be fixed on the bracket with the long side of the module, using a minimum of four clamps. Please make sure to use at least of two purlins behind the modules to support the modules.

The selection and installation of the clamps shall obey the requirement according to table 2. Otherwise the module may not satisfy the mechanical load and have the risk of broken.

The applied torque should be big enough to fix it steadily. The reference torque for screw is 16~20N\*m.

### 4.4 CLAMP INSTALLATION 2

The dual glass module with frame is designed for clamp installation. It needs the clamps, bolts, nuts and washers to fix on the bracket (as shown in figure 5 and figure 6). Sufficient torque should be applied to the bolts to ensure stable reinforcement. The reference torque value for M8 screw is 16~20N\*M.

Type	Loads(Pa)	Clamp Length	Installation Drawing
Type 1	+ 2400 - 2400	≥150mm	
Type 2	+ 2400 - 2400	≥200mm	
Type 3	+ 2400 - 2400	≥150mm	
Type 4	+ 2400 - 2400	≥200mm	

Table 2



Figure 3 Double-side clamp



Figure 4 Single-side clamp

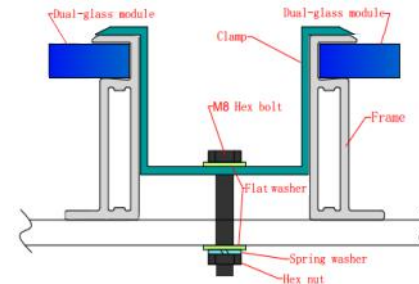

Figure 5 Double-side clamp installation

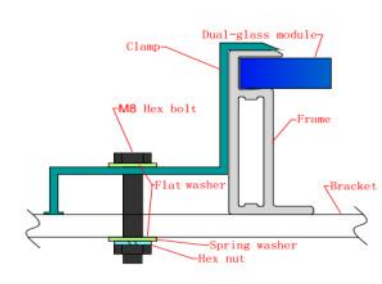

Figure 6 Single-side clamp installation

In order to ensure that the modules can withstand a downward force of up to 5400 Pa (550 kg/m<sup>2</sup>), the modules shall be fixed on the bracket with the long side of the module, using a minimum of four clamps. Please make sure to use at least of two purlins behind the modules to support the modules.

The selection and installation of the clamps shall obey the requirement according to table 3. Otherwise the module may not satisfy the mechanical load and have the risk of broken.

Type	Loads(Pa)	Clamp Length	Installation Drawing
Type 1	+ 5400 - 2400	≥50mm	
Type 2	+ 5400 - 2400	≥50mm	
Type 3	+ 5400 - 2400	≥50mm	
Type 4	+ 5400 - 2400	≥50mm	
Type 5	+ 5400 - 2400	≥50mm	

Table 3

Type 6	+ 5400 - 2400	≥50mm	
Type 7	+ 5400 - 2400	≥50mm	

#### 4.5 SCREW INSTALLATION

The dual glass module with frame is also designed for screw installation. It needs the screws, bolts, nuts and washers to fix on the bracket(as shown in fig7). Sufficient torque should be applied to the bolts to ensure stable reinforcement. The reference torque value for M8 screw is 16~20N\*M.

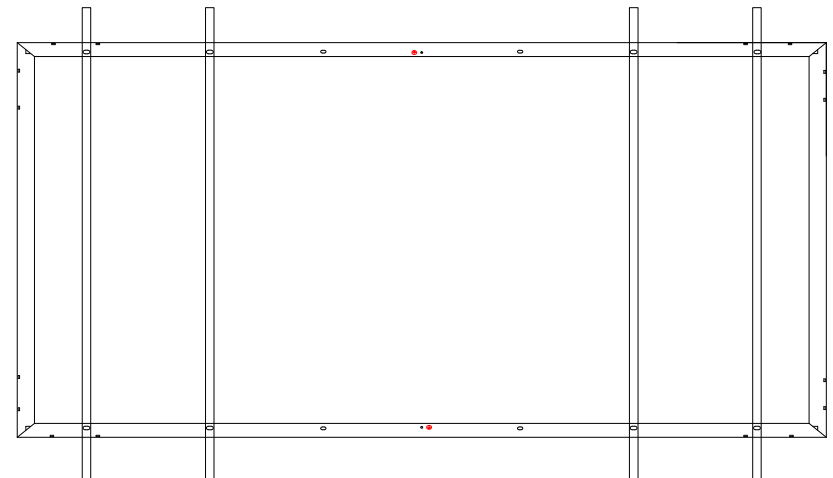

(8 mounting holes for 166 modules and 182-BMB)

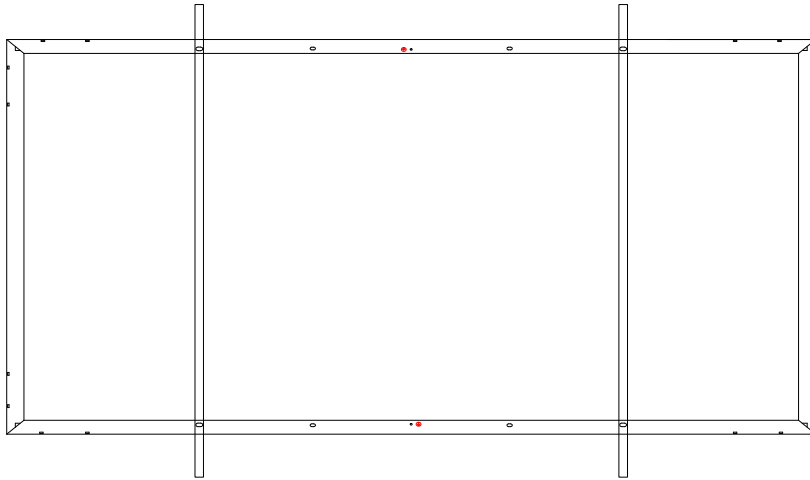

(4 mounting holes for 182-BMA/BMD&210 modules)

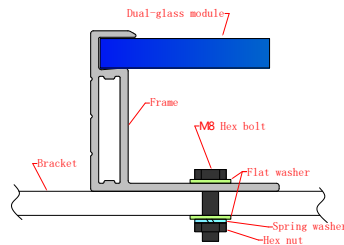

Figure 7 M8 Screw installation

In order to ensure that the modules can withstand a downward force of up to 2400 Pa (244 kg/m<sup>2</sup>), the modules shall be fixed on the bracket with the long side of the module, using a minimum of four screws. Please make sure to use at least of two purlins behind the modules to support the modules.

For 166 modules, the selection and installation of the screws shall obey the requirement according to table 4-1. Otherwise the module may not satisfy the mechanical load and have the risk of broken.

Installation Site	Loads(Pa)	Screw Number	Installation Drawing
Outer four holes (For 166 modules and 182-BMB)	+ 2400 - 2400	4	
Inner four holes (For 166 modules and 182-BMB)	+ 2400 - 2400	4	
Inner four holes + Outer four holes (For 166 modules and 182-BMB)	+ 5400 - 2400	8	
Nexttracker holes (Only for 72 type module of 166)	+ 2400 - 2400	4	

Table 4-1

For 182-BMA/BMD & 210 modules, four mounting holes are used for the frame in the standard industry, so as to facilitate customer installation. We used four mounting holes in the frame of 182-BMA/BMD & 210 modules (shown on Table 4-2).





Installation Site	Loads(Pa)	Screw Number	Installation Drawing
Four holes (For 182-BMA/BMD &210 modules)	+ 5400 - 2400	4	
Nextracker holes (Only for 72 type module of 182)	+ 2400 - 2400	4	

Table 4-2

## 4.6 ELECTRICAL INSTALLATION

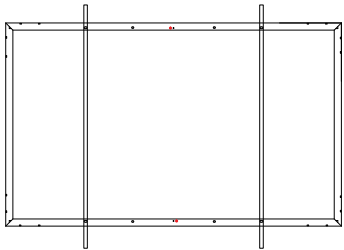
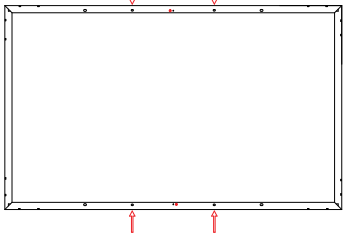

**WARNING** Electrical Hazard  
This module produces electricity when exposed to light. Follow all applicable electrical safety precautions.

- ONLY qualified personnel can install or perform maintenance work on these PV modules.
- BE AWARE of dangerous high DC voltage when connecting module.
- DO NOT damage or scratch the rear surface of the module.
- DO NOT handle or install module when they are wet.

The wiring components shall be compatible with the PV modules.

The PV modules connected in serial shall have similar current. The Voc of one PV string shall no higher than the maximum system voltage, the Voc temperature coefficient feature and the extreme low temperature of installation location must be taken into consideration when calculate the Voc of the PV string .

The PV modules connected in parallel shall have similar Voltage. The Isc temperature coefficient feature and the extreme high temperature of installation location must be taken into consideration when calculate the Isc of the PV array.

Please refer to local regulations to determine the system wires size, type and temperature.

The cross-sectional area and cable connector capacity must satisfy the maximum short-circuit of PV system (For a single component, we recommended the cross-sectional area of cables is 4mm<sup>2</sup> and the rated current of connectors is more than 15A), otherwise cables and connectors will become overheating for large current. Please pay attention: the temperature limit of cables is 85°C and the temperature limit of connector is 105°C

A qualified system designer or integrator should always be consulted.

Building permits, inspections and approvals by the local utility are generally required.

Before installation, make sure that the connector is well protected and there should be no foreign matter such as soil, sand and gravel in the connector. If any, it must be cleaned before installation. If the connector is damaged or deformed, the connector must be replaced before use; if there is no spare connector, please contact seraphim in time .

Remark : If conversion cable is needed, see attachment1 for details.

## 5 MAINTENANCE

Clean the glass surface of the module regularly with clean water and a soft sponge or cloth. A mild, non-abrasive cleaning agent may be used to remove stubborn dirt.

Check the electrical, grounding and mechanical connections every six months to verify that they are clean, secure, undamaged and free of corrosion.

If any problem arises, consult a professional for suggestions.

Caution: observe the maintenance instructions for all components used in the system, such as support frames, charging regulators, inverters, batteries etc.

## 6 PARAMETERS

The parameters may be updated time to time, accurate parameters please check on our website: <http://www.segsolar.com> or email to our technical support team: [technic@segsolar.com](mailto:technic@segsolar.com).

### 【1】REMARK

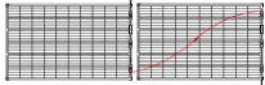
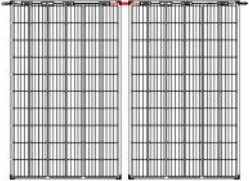
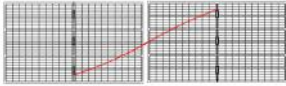
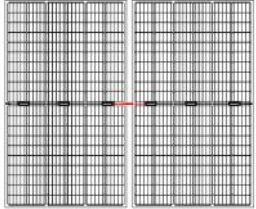
Module Type	Landscape installation	Portrait installation
Type1 Type2		
Type3 Type4		

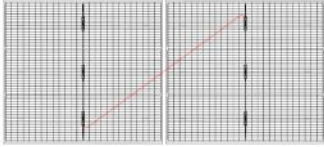
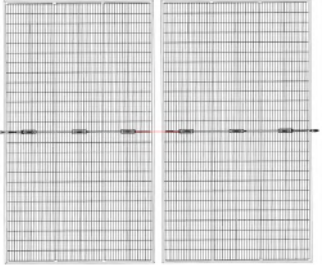
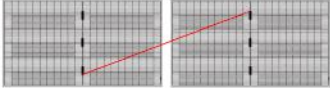
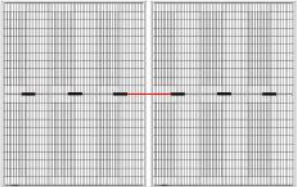
Type5		
Type6		
Type7	